

 Keep these instructions with the controller!

## Installation

### Place of installation

- In a dry room, e.g. the heat exchanger room
- Mounting choices:
  - In a compact station
  - In a control panel (in the front, on the inner wall, or on a top hat rail)
  - In the sloping front of a control desk
- Permissible ambient temperature: 0...50 °C

### Electrical installation

- Local regulations for electrical installations must be complied with
- Only qualified staff may carry out electrical installations
- Cable tension relief must be ensured
- Cable glands made of plastic must be used
- The cables from the controller to the actuators and pumps carry mains voltage
- The cables to the sensors may not be run parallel to mains carrying cable (safety class II to EN 60730!)
- If a device is defective or damaged, immediately disconnect it from power and replace it

### Permissible cable lengths

- For all sensors:
 

Copper cable 0.6 mm dia.	20 m max.
Copper cable 1.0 mm <sup>2</sup>	80 m max.
Copper cable 1.5 mm <sup>2</sup>	120 m max.
- For room units:
 

Copper cable 0.25 mm <sup>2</sup>	25 m max.
Copper cable from 0.5 mm <sup>2</sup>	50 m max.
- For the data bus
 

Copper cable ≥0.25 mm <sup>2</sup>	1000 m max.
------------------------------------	-------------

 (2-wire, twisted pairs, shielded)  
 For details, refer to the modbus specification

### Mounting and wiring the base

#### Wall mounting

1. Separate base from the controller
2. Hold base against the wall. Marking "TOP" must be at the top!
3. Mark fixing holes on the wall
4. Drill holes
5. If required, knock out holes on the base for cable glands
6. Screw base to the wall
7. Wire up base

#### Rail mounting

1. Fit top hat rail
2. Separate base from the controller
3. If required, knock out holes on the base for cable glands
4. Fit base to the rail. Marking "TOP" must be at the top!
5. If required, secure base (depending on the type of rail used)
6. Wire up base

#### Flush panel mounting

- Maximum thickness: 3 mm
  - Panel cutout required: 138 × 92 mm
1. Separate base from the controller
  2. If required, knock out holes on the base for cable glands
  3. Insert base in the panel cutout from behind until stop is reached. Marking "TOP" must be at the top!
  4. Push lateral tongues behind the front panel (refer to illustration below)

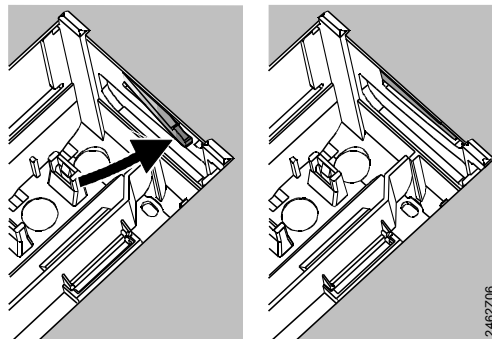

Wrong

Correct

Place tongues on both sides correctly – they may not be located inside the cutout!

5. Wire up base. Make sure the cable lengths are such that there is sufficient space to open the control panel door

### Securing the controller to the base

1. Ensure correct position and location of levers by turning the fixing screws (refer to illustration on the lateral wall of the unit)

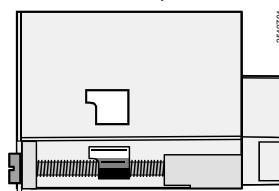





2. Insert controller in the base until stop is reached. Marking "TOP" must be at the top!
3. Tighten fixing screws alternately







# Commissioning

## Preparatory checks

- DO NOT switch on power supply yet
- Check wiring according to the plant connection diagram
- Check each motorized valve: see if
  - it is correctly installed (observe direction of flow indicated on the valve body)
  - the manual lever is disengaged
- Note with underfloor and ceiling heating systems!**  
The limit thermostat must be set to the correct value. During the functional test, the flow temperature may not exceed the maximum permissible level (usually 55 °C). If it does, proceed immediately as follows:
  - Either close the valve manually, or
  - Switch off the pump, or
  - Close the pump isolating valve
- Switch on power supply. The display must show the time of day. If not, the reason may be one of the following:
  - No mains voltage present
  - Main fuse defective
  - Mains isolator or main switch not set to ON
- If one of the operating mode buttons flashes, the room unit overrides the controller. Select operating mode  on the room unit

## General information about operation



- Setting elements for commissioning:
  - Nominal room temperature setpoint: with the setting knob
  - Other variables: in the display, where one operating line is assigned to each setting
- Buttons for selecting and readjusting the values:
  -  To select the next operating line below
  -  To select the next operating line above
  -  To decrease the displayed value
  -  To increase the displayed value
- Adopting a setting value:  
The setting value is adopted by selecting the next operating line (or by pressing one of the operating mode buttons)

- Entering --. / --:-- / --- (deactivating a function):  
Keep  or  depressed until the required display appears
- Block jump function:  
To select a single operating line quickly, two button combinations can be used:  
Keep  depressed and press  to select the next line block above  
Keep  depressed and press  to select the next line block below
- The display lighting turns on for a period after pushing a button

### Setting procedure

-  Enter all adjusted values in the tables provided!
- Make settings on the “End-user“ level (operating lines 1...49)
  - Configure plant type on operating lines 51...55
  - Make the relevant settings in the parameter list below. All functions and operating lines configured for the type of plant are activated and adjustable. All operating lines that are not required are locked.
  - Make settings on the “Heating engineer’s“ level (operating lines 56...222).
  - Make settings on the “Locking functions“ level (operating lines 226...251)

### Commissioning and functional check

- Specific operating lines for the functional check:
  - 141 = sensor test
  - 142 = relay test
  - 149 = reset of service settings
- If **Er** (Error) appears in the display: interrogate operating line 50 to pinpoint error
- If no line selection button has been pressed for eight minutes, or if one of the operating mode buttons is pressed (controller in the non-operated status), setting buttons  and  can be used to prompt all actual values and the time of day. The actual values are presented like those on operating line 141.

## Setting elements

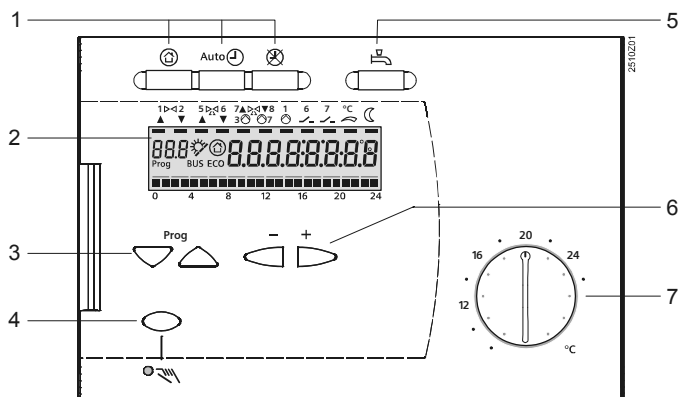

- Operating mode buttons
- Display (LCD)
- Buttons for selecting operating lines
- Button for manual operation ON / OFF
- Button for d.h.w. heating ON / OFF
- Buttons for making readjustments of values
- Setting knob for nominal room temperature setpoint

# Connection diagrams

## Low voltage side

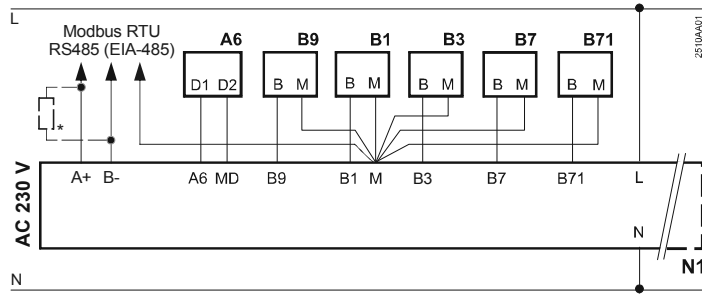

**RVD120**

\* Terminating resistor 150 Ω (0.5 W) for the first and last device on the bus.  
See Modbus specification for details

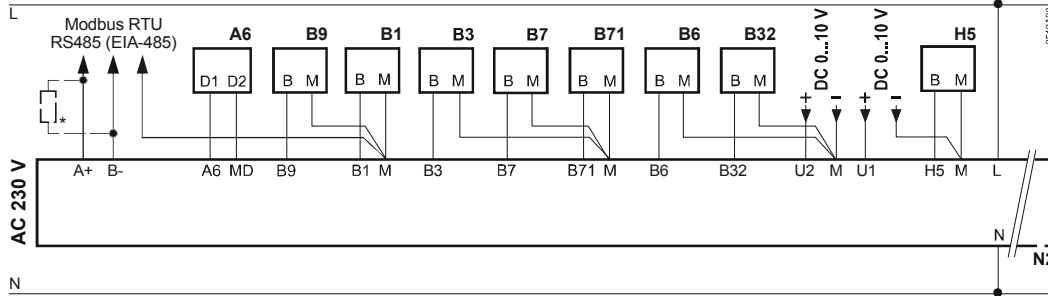

**RVD140**

## Mains voltage side

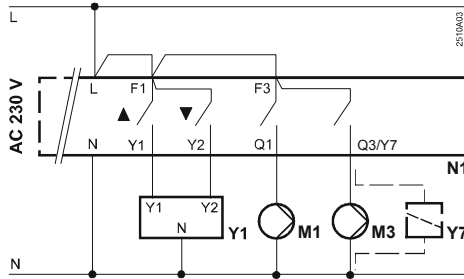

**RVD120 (plant types 1, 2 and 3)**

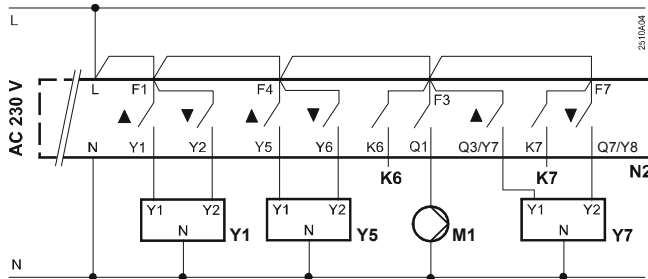

**RVD140 (plant type 5)**  
Three actuators and one pump

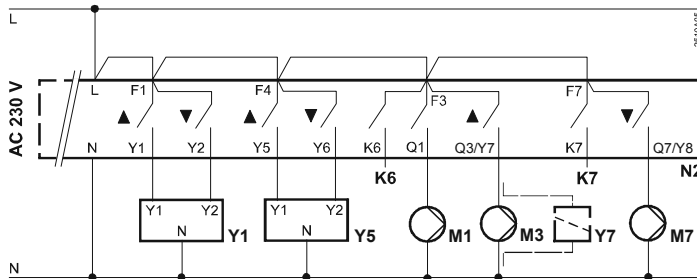

**RVD140 (plant types 1, 2, 3, 4, 6, 7 and 8)**  
Two actuators and three pumps or two pumps and one changeover valve





A6	Room unit
B1	Flow sensor
B3	D.h.w. sensor / storage tank sensor 1
B32	Storage tank sensor 2
B6	Collector sensor
B7	Primary return sensor
B71	Universal sensor
B9	Outside sensor
H5	Flow switch
K6 and K7	Multifunctional outputs for refill function / electric immersion heater / collector pump

M1	Heating circuit pump
M3	D.h.w. charging pump
M7	Circulating pump
Modbus RTU	Data bus
N1	Controller RVD120
N2	Controller RVD140
U1	Secondary pressure sensor
U2	Primary pressure sensor
Y1	Actuator of two-port valve in the primary return
Y5	Actuator of two-port valve / mixing valve
Y7	Actuator of changeover valve / mixing valve

# Parameter list

## Settings on the “End-user“ level

Press  or  to activate the “End-user“ level

Line	Function, display	Factory setting (Range)	Setting	Explanations, notes and tips
1	Current nominal room temperature setpoint	Display function		Including room unit
2	Reduced room temperature setpoint	14 °C (variable*)	.....°C	* From frost protection setpoint to nominal setpoint
3	Frost protection / holiday mode setpoint	8 °C (variable*)	.....°C	* From 8 °C to reduced setpoint Holiday setting only with room unit
5	Heating curve slope	1.5 (0.25...4.0)		
6	Weekday, for entering the heating program	Current weekday (1...7 / 1-7)		1 = Monday 2 = Tuesday etc. 1-7 = entire week
7	Heating period 1 start	6:00 (--:-- / 00:00...24:00)		Switching program for heating circuit --:-- = period inactive
8	Heating period 1 end	22:00 (--:-- / 00:00...24:00)		Switching program for heating circuit --:-- = period inactive
9	Heating period 2 start	--:-- (--:-- / 00:00...24:00)		Switching program for heating circuit --:-- = period inactive
10	Heating period 2 end	--:-- (--:-- / 00:00...24:00)		Switching program for heating circuit --:-- = period inactive
11	Heating period 3 start	--:-- (--:-- / 00:00...24:00)		Switching program for heating circuit --:-- = period inactive
12	Heating period 3 end	--:-- (--:-- / 00:00...24:00)		Switching program for heating circuit --:-- = period inactive
13	Time of day	(00:00...23:59)		
14	Weekday	Display function		1 = Monday 2 = Tuesday etc.
15	Date	(01.01...31.12)		Day.Month
16	Year	(2009...2099)		
17	Weekday, for entering the d.h.w. program	Current weekday (1...7 / 1-7)		1 = Monday 2 = Tuesday etc. 1-7 = entire week
18	Release period 1 start	6:00 (--:-- / 00:00...24:00)		Switching program for d.h.w. --:-- = period inactive
19	Release period 1 end	22:00 (--:-- / 00:00...24:00)		Switching program for d.h.w. --:-- = period inactive
20	Release period 2 start	--:-- (--:-- / 00:00...24:00)		Switching program for d.h.w. --:-- = period inactive
21	Release period 2 end	--:-- (--:-- / 00:00...24:00)		Switching program for d.h.w. --:-- = period inactive
22	Release period 3 start	--:-- (--:-- / 00:00...24:00)		Switching program for d.h.w. --:-- = period inactive
23	Release period 3 end	--:-- (--:-- / 00:00...24:00)		Switching program for d.h.w. --:-- = period inactive
24	Room temperature	Display function		
25	Outside temperature	Display function		Press  and  for 3 s: actual outside temperature will be adopted as the attenuated outside temperature
26	D.h.w. temperature	Display function		
27	Flow temperature heating circuit	Display function		Keep  or  depressed: current setpoint is displayed
41	Setpoint d.h.w. temperature NORMAL	55 °C (variable)	.....°C	
42	Setpoint d.h.w. temperature REDUCED	40 °C (variable*)	.....°C	* From 8 °C to normal d.h.w. setpoint

49	Reset of operating lines 2...12, 17...23 and 41, 42		Press $\leftarrow$ and $\rightarrow$ until display changes: 0 (flashing) = normal status 1 = reset to factory settings completed
50	Faults	Display function	10 = fault outside sensor 30 = fault flow sensor 40 = fault return sensor (primary side) 42 = fault return sensor (secondary side) 50 = fault d.h.w sensor / storage tank sensor 1 52 = fault storage tank sensor 2 61 = fault room unit 62 = connected unit shows wrong identification 73 = fault collector sensor 78 = fault secondary pressure sensor 86 = short-circuit on room unit bus (PPS) 170 = fault primary pressure sensor 195 = maximum refill period per charge reached 196 = maximum refill period per week reached

### Settings on the “Heating engineer’s” level

Press  $\nabla$  and  $\triangle$  simultaneously for 3 seconds, thus activating the “Heating engineer’s” level for configuring the plant type and for setting the plant-related variables. The “End-user” level remains activated.

#### Configuration of plant

The required plant type must be configured on operating lines 51...55. This activates all functions and operating lines required for the particular type of plant, which can then be set.

51	Plant type	1 (1...3 or 1...8)		<b>RVD120:</b> range 1...3 <b>RVD140:</b> range 1...8 For the diagrams, refer to the following section	
52	Space heating present <b>Only with plant types 2...8</b>	1 (0 / 1)		0 = no space heating present 1 = space heating present	
53	Use of universal sensor <b>Only with plant types 4, 6, 7</b>	1 (0 / 1)		0 = secondary return sensor 1 = d.h.w. sensor	
54	Flow switch present / circulating pump present (heat losses are compensated)	0 (0...3)		<i>Flow switch present</i>	<i>Circulating pump present</i>
				0 = no	insignificant (heat losses fully compensated [100 %])
				1 = yes	no
				2 = yes	yes, heat losses partly compensated (80 %)
				3 = yes	yes, heat losses fully compensated (100 %)
55	Return flow of circulating pump	0 (0...2)		0 = d.h.w. storage tank / no circulating pump 1 = heat exchanger, heat losses partly compensated (80 %) 2 = heat exchanger, heat losses fully compensated (100 %)	
56	Periodic pump run (pump kick)	1 (0 / 1)		0 = no periodic pump run 1 = weekly pump run enabled	
57	Winter- / summertime changeover	25.03 (01.01...31.12)		Setting: the earliest possible changeover date	
58	Summer- / wintertime changeover	25.10 (01.01...31.12)		Setting: the earliest possible changeover date	

# Plant types

**Plant type 1 – RVD120 and RVD140**

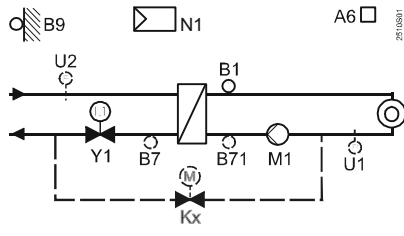

**Plant type 2 – RVD120 and RVD140**

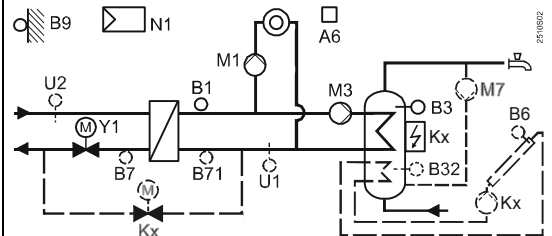

**Plant type 3 – RVD120 and RVD140**

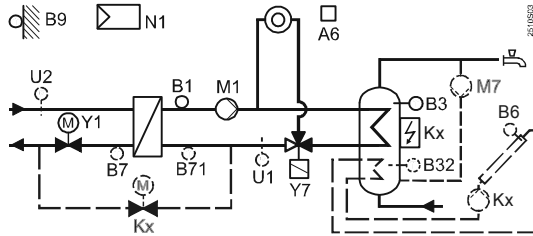

**Plant type 4 – only RVD140**

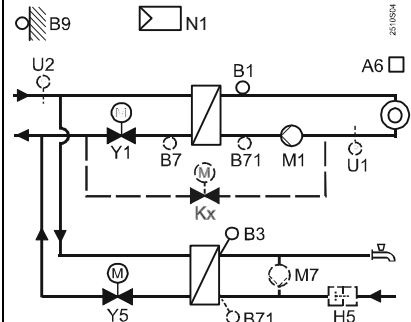

**Plant type 5 – only RVD140**

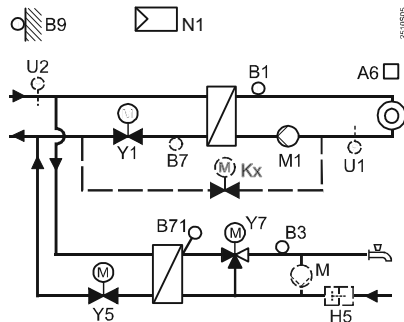

**Plant type 6 – only RVD140**

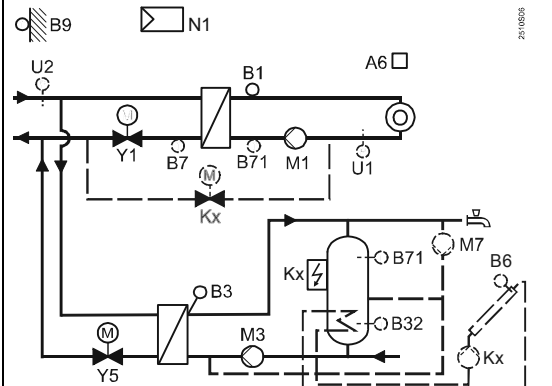

**Plant type 7 – only RVD140**

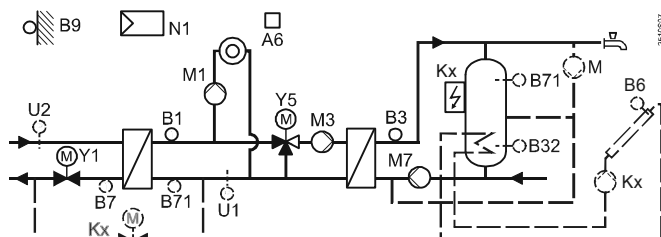

**Plant type 8 – only RVD140**

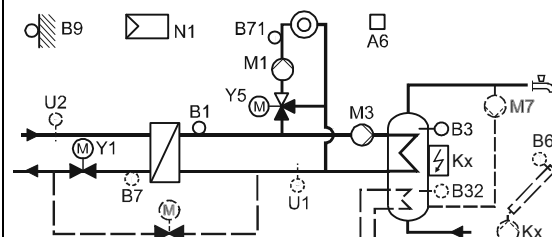

- A6 Room unit
- B1 Flow sensor (controlled variable)
- B3 D.h.w. sensor / storage tank sensor 1
- B32 Storage tank sensor 2 (only with RVD140)
- B6 Collector sensor (only with RVD140)
- B7 Primary return sensor
- B71 Universal sensor
- B9 Outside sensor
- H5 Flow switch
- Kx Multifunctional output K6 or K7 (only with RVD140)

- M1 Heating circuit pump
- M3 D.h.w. charging pump
- M7 Circulating pump (only with RVD140)
- M External circulating pump
- N1 Controller
- U1 Secondary pressure sensor (only with RVD140)
- U2 Primary pressure sensor (only with RVD140)
- Y1 Two-port valve in the primary return
- Y5 Two-port valve / mixing valve
- Y7 Changeover valve

## Heating slope chart

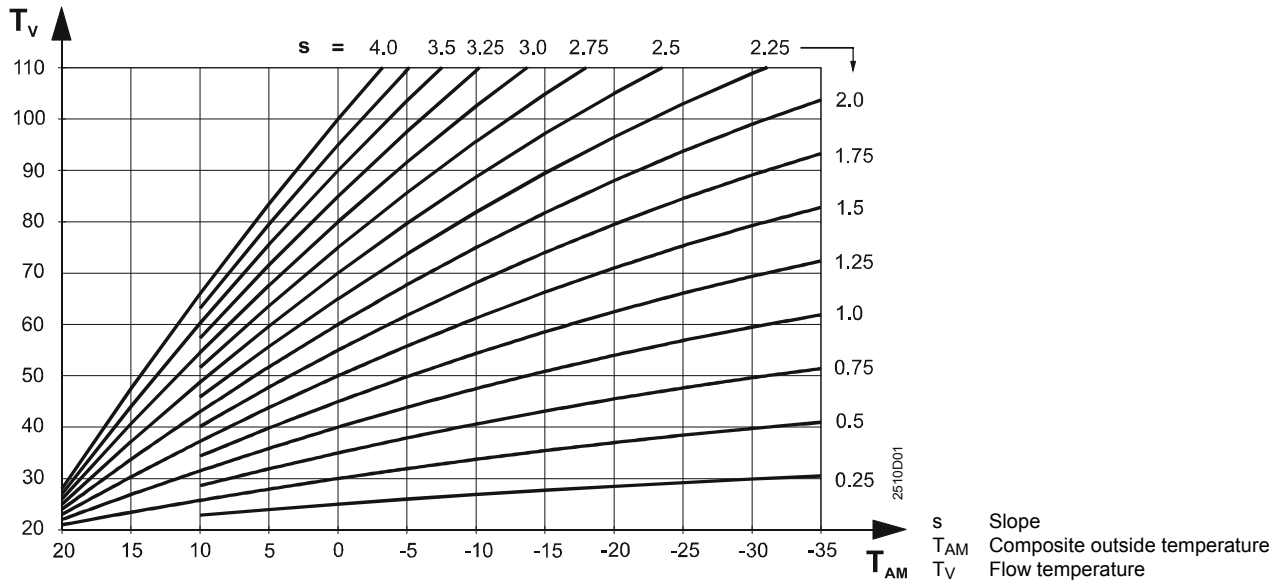

## Function blocks

### Block "Space heating"

61	Heating limit (ECO)	-3 K (--- / -10...+10)	.....K	--- = function deactivated
62	Building structure	1 (0 / 1)	.....	0 = heavy 1 = light
63	Quick setback without room sensor	1 (0...15)	.....	0 = no quick setback 1 = min. setback time 15 = max. setback time
69	Heat gains	0 K (-2...+4)	.....K	Setting in K room temperature
70	Room temperature influence (gain factor)	10 (0...20)	.....	Function can be provided only with room sensor
71	Parallel displacement of heating curve	0.0 K (-4.5...+4.5)	.....K	Setting in K room temperature
72	Overrun time heating circuit pump	4 min (0...40)	.....min	0 = no pump overrun
73	Frost protection for the plant	1 (0 / 1)	.....	0 = no frost protection for the plant 1 = frost protection for the plant
74	Max. limitation of room temperature	--- K (--- / 0.5...4)	.....K	Limit value: nominal setpoint plus setting on this line --- = function deactivated

### Block "Actuator heat exchanger"

81	Actuator Y1 running time common flow	120 s (10...873)	.....s	
82	P-band common flow control	35 K (1...100)	.....K	
83	Integral action time common flow control	120 s (10...873)	.....s	
85	Max. limitation of common flow temperature	--- °C (--- / variable*...140)	.....°C	* Min. value on operating line 86 --- = no limitation
86	Min. limitation of common flow temperature	--- °C (--- / 8...variable*)	.....°C	* Max. value on operating line 85 --- = no limitation

### Block "Actuator heating circuit"

91	Actuator running time heating circuit	120 s (10...873)	.....s	
92	P-band heating circuit control	35 K (1...100)	.....K	
93	Integral action time heating circuit control	120 s (10...873)	.....s	
94	Setpoint boost for control of the common flow (B1 and Y1)	10 K (0...50)	.....K	

95	Max. limitation of flow temperature heating circuit	--- °C (--- / variable*...140)	.....°C	* Min. value on operating line 96 --- = no limitation
96	Min. limitation of flow temperature heating circuit	--- °C (--- / 8...variable*)	.....°C	* Max. value on operating line 95 --- = no limitation

Block "D.h.w heating"

98	D.h.w. temperature sensor	0 (0...2)	.....	0 = automatically, without solar d.h.w. heating 1 = one sensor with solar d.h.w. heating 2 = two sensors with solar d.h.w heating Plant types without solar d.h.w. heating: setting = 0	
101	Release of d.h.w. heating	0 (0...3)	.....	0 = permanently (24 h/day) 1 = according to the d.h.w. program 2 = according to the heating program 3 = according to the heating program with forward shift (operating line 109)	
102	Release of circulating pump	1 (0...2)	.....	0 = permanently (24 h/day) 1 = according to the d.h.w. program 2 = according to the heating program	
103	D.h.w. switching differential	5 K (1...20)	.....K		
104	Legionella function	6 (--- / 1...7, 1-7)	.....	1 = Monday 2 = Tuesday etc. 1-7 = entire week --- = no legionella function	
105	Setpoint legionella function	65 °C (60...95)	.....°C		
106	D.h.w. priority	4 (0...4)	.....	<i>D.h.w. priority</i>	<i>Flow temp. setpoint according to:</i>
				0 = absolute priority	d.h.w.
				1 = shifting priority	d.h.w.
				2 = shifting priority	max. selection
				3 = none (parallel)	d.h.w.
4 = none (parallel)	max. selection				
107	Overrun time charging pump M3	4 min (0...40)	.....min	Plant type 3: changeover valve Y7	
108	Overrun time charging pump (M7 in the secondary d.h.w. circuit, after M3)	4 min (0...40)	.....min		
109	Max. time d.h.w. heating	150 min (--- / 5...250)	.....min	--- = function deactivated	

Block "D.h.w. actuator 1"

111	Opening time actuator Y5 d.h.w. circuit	35 s (10...873)	.....s	
112	Closing time actuator Y5 d.h.w. circuit	35 s (10...873)	.....s	
113	P-band d.h.w. control	35 K (1...100)	.....K	
114	Integral action time d.h.w. control	35 s (10...873)	.....s	
115	Derivative action time d.h.w. control	16 s (0...255)	.....s	
116	Setpoint boost with d.h.w. heating	16 K (-5...50)	.....K	
117	Max. d.h.w. temperature setpoint	65 °C (20...95)	.....°C	
119	Reduced d.h.w. setpoint for storage tank sensor at the bottom	5 K (0...20)	.....K	Only when two sensors exist

Block "D.h.w. actuator 2"

121	Actuator running time, mixing valve Y7 in the secondary d.h.w. circuit	35 s (10...873)	.....s	
122	P-band d.h.w. control	35 K (1...100)	.....K	
123	Integral action time d.h.w. control	35 s (10...873)	.....s	



Block "D.h.w. load limit"

124	Load limit when flow switch is activated	25 % (0...60)	.....%	Setting in % of the current max. stroke
-----	--	------------------	--------	---

Block "Additional legionella functions"

126	Time for charging	--:-- (--:-- / 00:00...23:50)	.....	
127	Dwelling time at legionella setpoint	--- min (--- / 10...360)	.....min	
128	Circulating pump operation during legionella function	1 (0 / 1)	.....	0 = no 1 = yes

Block "Multifunctional relays"

129	Function multifunctional relay K6	0 (0...3)	.....	0 = no function 1 = refill function 2 = electric immersion heater 3 = collector pump No prevention of wrong configurations!
130	Function multifunctional relay K7	0 (0...3)	.....	0 = no function 1 = refill function 2 = electric immersion heater 3 = collector pump No prevention of wrong configurations!

Block "Test and display"

141	Sensor test --- = open circuit or no sensor ooo = short-circuit	0 (0...9)		0 = outside sensor (B9) 1 = flow sensor (B1) 2 = d.h.w. sensor / storage tank sensor 1 (B3) 3 = room unit sensor (A6) 4 = primary return sensor (B7) 5 = universal sensor (B71) 6 = storage tank sensor 2 (B32) 7 = collector sensor (B6) 8 = secondary pressure sensor (U1) 9 = primary pressure sensor (U2)
142	Relay test	0 (0...10)		0 = normal operation (no test) 1 = all relays de-energized 2 = relay Y1 energized 3 = relay Y2 energized 4 = relay Q1 energized 5 = relay Q3/Y7 energized 6 = relay Y5 energized 7 = relay Y6 energized 8 = relay Q7/Y8 energized 9 = relay K6 energized 10 = relay K7 energized  <i>To terminate the relay test:</i> <ul style="list-style-type: none"> <li>• Select another operating line</li> <li>• Press an operating mode button</li> <li>• Automatically after 8 minutes</li> </ul> <i>Note:</i> With plant type 5, perform relay test only when main valve is closed! Recommendation: Always close main valve when making the relay test

143	Display of active limitations	Display function	<i>Maximum limitation f</i> : 1 = primary return temperature 2 = common flow temperature 3 = secondary flow temperature heating circuit 4 = temperature differential 5 = room temperature 6 = storage tank charging temperature 7 = storage tank maximum temperature 8 = evaporation temperature heat carrier 9 = collector overtemperature protection  <i>Minimum limitation j</i> : 11 = reduced room temperature setpoint 12 = common flow temperature 13 = secondary flow temperature heating circuit
146	Status at terminal H5	Display function	H5 0 = H5 contact open H5 1 = H5 contact closed
149	Reset of operating lines 56...96, 101...128 and 201...221		Press $\leftarrow$ and $\rightarrow$ until display changes: 0 (flashing) = normal status 1 = reset to factory settings completed
150	Software version	Display function	

#### Block "Modbus parameter"

171	Unit number	--- (--- / 1...247)	.....	Modbus address --- = no data bus connection
172	Parity	0 (0...2)	.....	0 = even 1 = odd 2 = none
173	Baud rate	3 (0...4)	.....	0 = 1200 Baud 1 = 2400 Baud 2 = 4800 Baud 3 = 9600 Baud 4 = 19200 Baud
174	Modbus version	Display function		

#### Block "Solar d.h.w."

201	Temperature differential ON solar	8 K (0...40)	..... K	Temperature differential between collector and storage tank
202	Temperature differential OFF solar	4 K (0...40)	..... K	Temperature differential between collector and storage tank
203	Collector frost protection	--- °C (--- / -20...5)	..... °C	--- = no collector frost protection
204	Collector overtemperature protection	105 °C (--- / 30...240)	..... °C	--- = no collector overtemperature protection
205	Evaporation temperature heat carrier	140 °C (--- / 60...240)	..... °C	--- = no collector pump protection
206	D.h.w. charging temperature maximum limitation	80 °C (8...100)	..... °C	
207	D.h.w. storage tank temperature maximum limitation	90 °C (8...100)	..... °C	No safety function
208	Collector start function gradient	--- min/K (--- / 1...20)	.....min/K	--- = function deactivated

#### Block Refill function

211	Relative secondary minimum pressure	--- bar (--- / 0.5...10)	.....bar	--- = refill function inactive
212	Refill locking time after shut down	10 min (--- / 10...2400)	.....min	--- = function inactive
213	Minimum secondary under-pressure period	10 s (--- / 10...2400)	.....s	--- = function inactive
214	Secondary switching differential	0.3 bar (0.1...1.0)	.....bar	
215	Function primary pressure sensor U2	0 (0 / 1)	.....	0 = display function (see operating line 141) 1 = monitoring
216	Maximum refill period per charge	--- s (--- / 10...2400)	.....s	--- = function inactive
217	Maximum refill period per week	--- min (--- / 1...1440)	.....min	--- = function inactive

218	Secondary pressure sensor U1: Pressure at DC 10 V	10 bar (0...100)	.....bar	Scaling for DC 10 V
219	Secondary pressure sensor U1: Pressure at DC 0 V	0 bar (-10...0)	.....bar	Scaling for DC 0 V
220	Primary pressure sensor U2: Pressure at DC 10 V	10 bar (0...100)	.....bar	Scaling for DC 10 V
221	Primary pressure sensor U2: Pressure at DC 0 V	0 bar (-10...0)	.....bar	Scaling for DC 0 V
222	Reset of the counters "Refill period per charge" and "Refill period per week"			Press $\bar{\leftarrow}$ and $\bar{\rightarrow}$ until display changes: 0 (flashing) = normal status 1 = reset completed

## Settings on the "Locking functions" level

To access the "Locking functions" level, proceed as follows:

1. Press  $\nabla$  and  $\triangle$  simultaneously for 6 seconds
2. The display shows **Cod 00000**
3. Enter the code (for information about the code, contact your Siemens Service centre)

The "End-user" and "Heating engineer's" levels remain activated.

### Block "Locking functions"

226	Max. limitation of primary return temperature, constant value	--- °C (--- / 0...140)	.....°C	<p>--- = no limitation TRt = return temperature OpL = operating line TO = outside temperature</p>
227	Max. limitation of primary return temperature, slope	7 (0...40)	.....	
228	Max. limitation of primary return temperature slope, start of shifting limitation	10 °C (-50...+50)	.....°C	
229	Max. setpoint of return temperature with d.h.w. heating	--- °C (--- / 0...140)	.....°C	<b>Only with plant types 2, 3, 7 and 8</b> --- = function deactivated
230	Integral action time primary return temperature limitations	15 min (0...60)	.....min	
231	Max. limitation of temperature differential (between primary return and secondary return temperature)	-- °C (-- / 0.5...50.0)	.....°C	<b>Only with plant types 1, 2, 3, 4, 6 and 7</b> -- = function deactivated
232	Max. setpoint of the return temperature during d.h.w. heating on legionella setpoint	--- °C (--- / 0...140)	.....°C	
236	Raising the reduced room temperature setpoint	0 (0...10)	.....	Effect of outside temperature on the reduced setpoint of the room temperature 0 = function deactivated
237	Daily forced d.h.w. heating at the start of release period 1	1 (0 / 1)	.....	<b>Only with plant types 2, 3, 6, 7 and 8</b> 0 = function deactivated 1 = function activated
238	Idle heat function primary flow	--- min (--- / 3...255)	.....min	<b>Only with plant types 4 and 5</b> --- = function deactivated If B7 is available, place sensor as indicated:
251	Locking on the hardware side	0 (0 / 1)	.....	0 = no locking 1 = code can be entered only when terminals B71-M on the base are bridged

## Keep Instructions

Enter the settings and keep these Installation Instructions in a safe place!

## Dimensions

